



## Chimney hoods and heater



# INDEX

CHIMNEY HOODS **03-18**

SLIM HOODS **19-31**

GAS HEATERS **32-37**

CYLINDER CABINETS **38**





Material:Inox Aisi 430/304  
Lamp:LED 2X2W  
Switch:Electronic control  
Filter:3xAluminum panels  
Air outlet:150mm  
Dimension:900m  
G.W.: 15KGS(900M)  
Motor:1x330W  
Air flow:1000M3/Hr  
Optional:  
Air flow:700M3/Hr

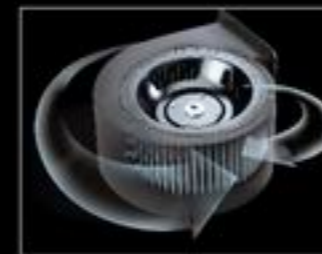
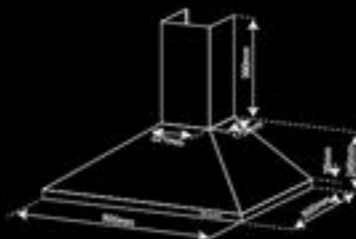

Material:Inox Aisi 430/304+toughen Glass  
Lamp:LED 2X2W  
Switch: LCD Touch control  
Filter:2xAluminum panels  
Air outlet:150mm  
Dimension:900mm  
G.W.:25KGS(900M)  
Motor:1x130W  
Air flow:1000M3/Hr  
Optional:  
Air flow:700M3/Hr

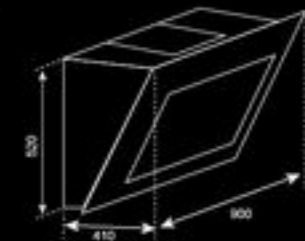

**TG**  
SERIES

SUNIDEA



Stainless steel (SS430) with tempered glass  
Air flow up to 750m<sup>3</sup>/hr  
Single motor: 1 x 196W  
LED lights: 2 x 2W  
3 speed ,push button  
washable aluminium filters  
Dimension: 900mm  
Air outlet: 150mm  
Plastic exhaust pipe: 1.5 meters



N.W.: 18.00KG / G.W.: 20.00KG  
Unit size: 900x500x480 / 860mm  
Packing size: 940x450x540mm  
Loading quantity: 20GP: 120PCS / 40GP: 248PCS / 40HQ: 296PCS

Optional:  
Dimension: 60cm, 70cm, 75cm, 80cm  
SS304  
Charcoal filter  
Air flow: 500m<sup>3</sup> /hr  
Touch screen switch / Electronic switch

## CHIMNEY HOODS



Stainless steel (SS430)  
Air flow up to 750m<sup>3</sup>/hr  
One motor:1 x 196W  
LED lights:2 x 2W  
3 speed ,push button  
washable aluminium filters  
Dimension:600mm  
Air outlet:150mm  
Plastic exhaust pipe:1.5meters

N.W.:14.00KG/G.W.:16.00KG  
Unit size:600x500x480/860mm  
Packing size:650x440x560mm  
Loading quantity:20GP:180PCS/40GP:360PCS /40HQ:432PCS

Optional:  
SS304  
Dimension:900mm  
Charcoal filter  
Air flow:500m<sup>3</sup>/hr  
Touch screen switch/Electronic switch

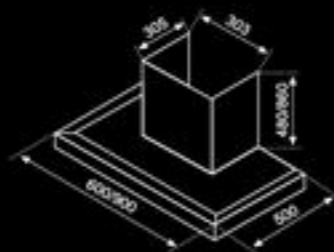

Stainless steel (SS430)  
Air flow up to 750m<sup>3</sup>/hr  
One motor:1 x 196W  
LED lights:2 x 2W  
3 speed ,push button  
washable aluminium filters  
Dimension:900mm  
Air outlet:150mm  
Plastic exhaust pipe:1.5meters

N.W.:14.00KG/G.W.:16.00KG  
Unit size:900x500x390/760mm  
Packing size:960x390x550mm  
Loading quantity:20GP:144PCS/40GP:290PCS /40HQ:340PCS

Optional:  
SS304  
Dimension:600mm  
Charcoal filter  
Air flow:500m<sup>3</sup>/hr

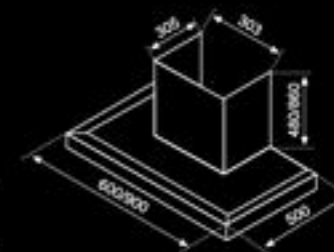

**TJ**  
SERIES



Stainless steel (SS430) with tempered glass  
Air flow up to 750m<sup>3</sup>/hr  
One motor: 1 x 196W  
LED lights: 2 x 2W  
3 speed ,push button  
washable aluminium filters  
Dimension: 600mm  
Air outlet: 150mm  
Plastic exhaust pipe: 1.5 meters

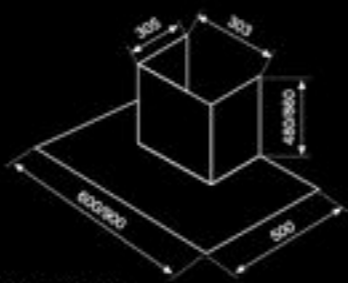

N.W.: 16.00KG / G.W.: 18.00KG  
Unit size: 600x500x480x860mm  
Packing size: 650x450x540mm  
Loading quantity: 20GP: 180PCS / 40GP: 360PCS / 40HQ: 432PCS

Optional:  
Dimension: 70cm, 75cm, 80cm or 90cm  
SS304  
Charcoal filter  
Air flow: 500m<sup>3</sup>/hr

# TG01 SERIES

SUNIDEA



# TG02 SERIES



Stainless steel (SS430) with tempered glass  
 Air flow up to 750m<sup>3</sup>/hr  
 One motor: 1 x 196W  
 LED lights: 2 x 2W  
 3 speed, Electronic switch+ display screen  
 washable aluminium filters  
 Dimension: 900mm  
 Air outlet: 150mm  
 Plastic exhaust pipe: 1.5meters  
 N.W.: 18.00KG / G.W.: 20.00KG  
 Unit size: 900x500x480 / 860mm  
 Packing size: 940x450x540mm  
 Loading quantity: 20GP: 120PCS / 40GP: 248PCS / 40HQ: 296PCS

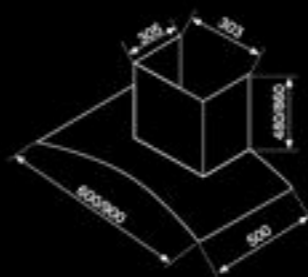

Optional:  
 Designer Hood, 70cm, 75cm, 80cm  
 SS304  
 Charcoal filter  
 Air flow: 500m<sup>3</sup> /hr



Stainless steel (SS430) with tempered glass  
 Air flow up to 750m<sup>3</sup>/hr  
 One motor: 1 x 196W  
 LED lights: 2 x 2W  
 Noise level: <math>+60\text{ dB}</math>  
 3 speed, Touch screen LCD  
 washable aluminium filters  
 Dimension: 900mm  
 Air outlet: 150mm  
 Plastic exhaust pipe: 1.5meters  
 N.W.: 18.00KG / G.W.: 20.00KG  
 Unit size: 900x500x480 / 860mm  
 Packing size: 940x450x540mm  
 Loading quantity: 20GP: 120PCS / 40GP: 248PCS / 40HQ: 296PCS

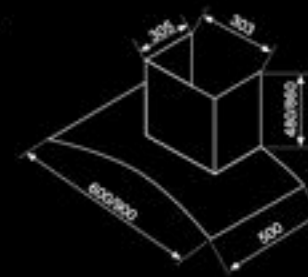

Optional:  
 Designer Hood 70cm, 75cm, 80cm  
 SS304  
 Charcoal filter  
 Air flow: 500m<sup>3</sup> /hr

# TG03 SERIES

SUNIDEA



# TG04 SERIES



Stainless steel (SS430) with tempered glass  
Air flow up to 750m<sup>3</sup>/hr  
One motor: 1 x 196W  
LED lights: 2 x 2W  
3 speed , push botton  
washable aluminium filters  
Dimension: 900mm  
Air outlet: 150mm  
Plastic exhaust pipe: 1.5meters

N.W.: 18.00KG / G.W.: 20.00KG  
Unit size: 900x500x480 / 860mm  
Packing size: 940x450x540mm  
Loading quantity: 20GP: 120PCS / 40GP: 248PCS / 40HQ: 296PCS

Optional:  
Dimension: 70cm, 75cm, 80cm  
SS304  
Charcoal filter  
Air flow: 500m<sup>3</sup> /hr  
Electronic switch

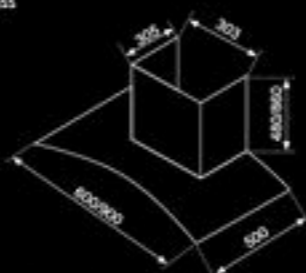

Stainless steel (SS430) with tempered glass  
Air flow up to 750m<sup>3</sup>/hr  
One motor: 1 x 196W  
LED lights: 2 x 2W  
3 speed , push botton +indicator light  
washable aluminium filters  
Dimension: 900mm  
Air outlet: 150mm  
Plastic exhaust pipe: 1.5meters

N.W.: 18.00KG / G.W.: 20.00KG  
Unit size: 900x500x480 / 860mm  
Packing size: 940x450x540mm  
Loading quantity: 20GP: 120PCS / 40GP: 248PCS / 40HQ: 296PCS

Optional:  
Dimension: 70cm, 75cm, 80cm  
SS304  
Charcoal filter  
Air flow: 500m<sup>3</sup> /hr  
Electronic switch

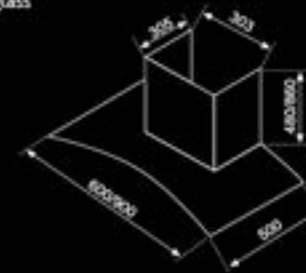





Material:Inox Aisi 430/304+toughen Glass  
Lamp:LED 2X2W  
Switch: LCD Touch control (with TV)  
Filter:2xAluminum panels  
Air outlet:150mm  
Dimension:900mm/600mm  
G.W.:25KGS(900M)  
Motor:1x130W  
Air flow:1000M3/Hr  
Optional:  
Air flow:700M3/Hr

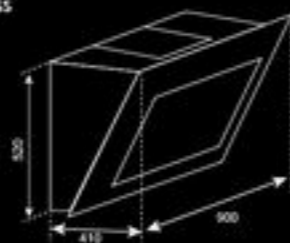

Material:Inox Aisi 430/304+toughen Glass  
Lamp:LED 2X2W  
Switch:Touch control  
Filter:1xAluminum panels  
Air outlet:150mm  
Dimension:900mm  
G.W.:25KGS(900M)  
Motor:1x330W  
Air flow:1000M3/Hr  
Optional:  
Air flow:700M3/Hr

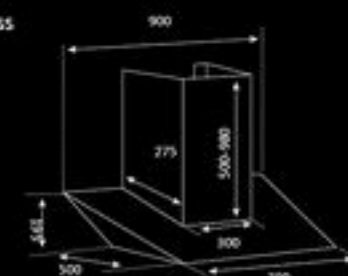

SUNIDEA



**TP90**  
SERIES



Material:Inox Aisi 430/304+toughen Glass  
Lamp:LED 2X2W  
Switch:Electronic button  
Filter:2xAluminum panels  
Air outlet:150mm  
Dimension:900mm  
G.W.:25KGS(900M)  
Motor:1x330W  
Air flow:1000M3/Hr  
Optional:  
Air flow:700M3/Hr

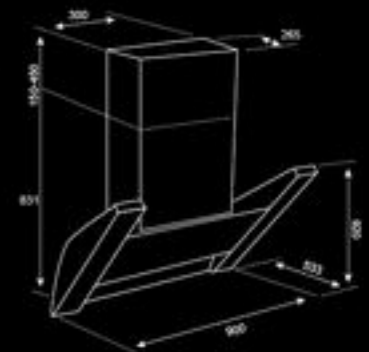



**TK60**



**WTB90SS20MPMN**



**Standard Feature:**  
430 Stainless steel finish+ powder coating design  
2 speed Mechanical switch;  
Cassette Aluminum filter;  
Maximum Capacity 450M3/H;  
60cm wide work area;  
two motor;  
Normal Lamp 2x15W  
Air outlet:120mm

**Optional Feature:**  
Carbon filter;  
Full powder coating design;  
60-90cm wide work area are available;

**Loading quantity:**  
60CM: 20GP:570PCS/40GP:1140PCS /40HQ:1350PCS  
70CM: 20GP:480PCS/40GP: 920PCS /40HQ:1107PCS  
80CM: 20GP:420PCS/40GP: 850PCS /40HQ:967PCS  
90CM: 20GP:380PCS/40GP:768 PCS /40HQ:860PCS



**Standard Feature:**  
Full stainless steel  
3 speed push bottom;  
Metal grease filter  
Maximum Capacity 450M3/H;  
90cm wide work area;  
Unit Size:900x490x135mm  
Two motor;  
Normal Lamp;  
Air outlet:120mm

**Optional Feature:**  
Single Motor;  
Full powder coating  
Carbon filter  
Cassette Aluminum filter;  
60-90cm wide work area are available;

**Unit size:**(600/700/750/800/900)x490x135mm  
**Packing size:**(64/74/84/94)x530x175mm  
**Loading quantity:**  
60CM: 20GP:520PCS/40GP: 1040 PCS /40HQ:1210PCS  
70CM: 20GP:440PCS/40GP:900 PCS /40HQ:1050PCS  
80CM: 20GP:390PCS/40GP: 780 PCS /40HQ:910PCS  
90CM: 20GP:340PCS/40GP: 690 PCS /40HQ:825PCS



**WTB90SS20APMN**



**WTE90SS20MPMN**



**Standard Feature:**  
Full stainless steel  
3 speed push bottom;  
Cassette Aluminum filter;  
Maximum Capacity 450M3/H;  
90cm wide work area;  
Unit Size:900x490x135mm  
Two motor;  
Normal Lamp;  
Air outlet:120mm

**Optional Feature:**  
Single Motor;  
Full powder coating  
Carbon filter  
Metal grease filter  
60-90cm wide work area are available;

Unit size:(600/700/750/800/900)x490x135mm  
Packing size:(64/74/84/94)x530x175mm  
Loading quantity:  
60CM: 20GP:520PCS/40GP: 1040 PCS /40HQ:1210PCS  
70CM: 20GP:440PCS/40GP: 900 PCS /40HQ:1050PCS  
80CM: 20GP:390PCS/40GP: 780 PCS /40HQ:910PCS  
90CM: 20GP:340PCS/40GP: 690 PCS /40HQ:825PCS



**Standard Feature:**  
Full stainless steel  
3 speed push bottom;  
Metal grease filter  
Maximum Capacity 450M3/H;  
90cm wide work area;  
Unit Size:900x500x150mm  
Two motor;  
Normal Lamp;  
Air outlet:120mm

**Optional Feature:**  
Single Motor;  
Full powder coating  
Carbon filter  
Cassette Aluminum filter;  
60-90cm wide work area are available;

Unit size:(600/700/750/800/900)x500x150mm  
Packing size:(630/730/830/930)x540x190mm  
Loading quantity:  
60CM: 20GP:480PCS/40GP:970PCS /40HQ:1100PCS  
70CM: 20GP:416PCS/40GP: 832PCS /40HQ:910PCS  
80CM: 20GP:364PCS/40GP:728PCS /40HQ:830PCS  
90CM: 20GP:320PCS/40GP:650 PCS /40HQ:700PCS

SUNIDEA



WT01  
SERIES



Ultra-thin body, simple style, exquisite craftsmanship, high airflow, low noise  
LED illumination makes your cooking even more brilliant!

*SLIM HOODS*



**WTD90FF20MPMN**



**WTD90SS20APMN**



**Standard Feature:**  
 Full powder coating  
 3 speed push bottom;  
 Metal grease filter  
 Maximum Capacity 440M3/H;  
 90cm wide work area;  
 Unit Size:900x510x150mm  
 two motor;  
 Normal Lamp;  
 Air outlet:120mm  
**Optional Feature:**  
 Single Motor;  
 Full stainless steel  
 Carbon filter  
 Cassette Aluminum filter;  
 Slide switch  
 50-90cm wide work area are available;

Unit size:(50/60/70/75/80/90)x50x15cm  
 Packing size:(54/64/74/79/84/94)x57x19cm  
**Loading quantity:**  
 50CM: 20GP:510PCS/40GP:1030PCS /40HQ:1200PCS  
 60CM: 20GP:432PCS/40GP:880PCS /40HQ:1020PCS  
 70CM: 20GP:380PCS/40GP:760PCS /40HQ:870PCS  
 75CM: 20GP:348PCS/40GP:700PCS /40HQ:814PCS  
 80CM: 20GP:336PCS/40GP:672PCS /40HQ:780PCS  
 90CM: 20GP:296PCS/40GP:600PCS /40HQ:700PCS



**Standard Feature:**  
 Full stainless steel  
 3 speed push bottom;  
 Cassette Aluminum filter;  
 Maximum Capacity 440M3/H;  
 90cm wide work area;  
 Unit Size:900x510x150mm  
 Two motor;  
 Normal Lamp;  
 Air outlet:120mm

**Optional Feature:**  
 Single Motor;  
 Full powder coating  
 Carbon filter  
 Metal grease filter  
 Slide switch  
 50-90cm wide work area are available;

Unit size:(50/60/70/75/80/90)x50x15cm  
 Packing size:(54/64/74/79/84/94)x57x19cm  
**Loading quantity:**  
 50CM: 20GP:510PCS/40GP:1030PCS /40HQ:1200PCS  
 60CM: 20GP:432PCS/40GP:880PCS /40HQ:1020PCS  
 70CM: 20GP:380PCS/40GP:760PCS /40HQ:870PCS  
 75CM: 20GP:348PCS/40GP:700PCS /40HQ:814PCS  
 80CM: 20GP:336PCS/40GP:672PCS /40HQ:780PCS  
 90CM: 20GP:296PCS/40GP:600PCS /40HQ:700PCS



**WTX90SS20APMN**



**WTX90SS20MPMN**



**Standard Feature:**  
Full stainless steel Full powder coating  
3 speed ,Slide switch  
Cassette Aluminum filter;  
Maximum Capacity 440M3/H;  
90cm wide work area;  
Unit Size:900x510x150mm  
two motor;  
Normal Lamp;  
Air outlet:120mm

**Optional Feature:**  
Single Motor;  
Full powder coating  
Carbon filter  
Metal grease filter  
push bottom;  
50-90cm wide work area are available;

Unit size:(50/60/70/75/80/90)x50x15cm  
Packing size:(54/64/74/79/84/94)x57x19cm  
Loading quantity:  
50CM: 20GP:510PCS/40GP:1030PCS /40HQ:1200PCS  
60CM: 20GP:432PCS/40GP:880PCS /40HQ:1020PCS  
70CM: 20GP:380PCS/40GP:760PCS /40HQ:870PCS  
75CM: 20GP:348PCS/40GP:700PCS /40HQ:814PCS  
80CM: 20GP:336PCS/40GP:672PCS /40HQ:780PCS  
90CM: 20GP:296PCS/40GP:600PCS /40HQ:700PCS



**Standard Feature:**  
Full stainless steel  
3 speed push bottom;  
Metal grease filter  
Maximum Capacity 440M3/H;  
90cm wide work area;  
Unit Size:900x510x150mm  
Two motor;  
Normal Lamp;  
Air outlet:120mm

**Optional Feature:**  
Single Motor;  
Full powder coating  
Carbon filter  
Cassette Aluminum filter  
Slide switch  
50-90cm wide work area are available;

Unit size:(50/60/70/75/80/90)x50x15cm  
Packing size:(54/64/74/79/84/94)x57x19cm  
Loading quantity:  
50CM: 20GP:510PCS/40GP:1030PCS /40HQ:1200PCS  
60CM: 20GP:432PCS/40GP:880PCS /40HQ:1020PCS  
70CM: 20GP:380PCS/40GP:760PCS /40HQ:870PCS  
75CM: 20GP:348PCS/40GP:700PCS /40HQ:814PCS  
80CM: 20GP:336PCS/40GP:672PCS /40HQ:780PCS  
90CM: 20GP:296PCS/40GP:600PCS /40HQ:700PCS



**WTE90SS20APMN**



**Standard Feature:**

- Full stainless steel
- 3 speed push bottom;
- Cassette Aluminum filter;
- Maximum Capacity 450M<sup>3</sup>/H;
- 90cm wide work area;
- Unit Size:900x500x150mm
- Two motor;
- Normal Lamp;
- Air outlet:120mm

**Optional Feature:**

- Single Motor;
- Full powder coating
- Carbon filter
- Metal grease filter
- 60-90cm wide work area are available;

- Unit size:(600/700/750/800/900)x500x150mm
- Packing size:(630/730/830/930)x540x190mm
- Loading quantity:
- 60CM: 20GP:480PCS/40GP:970PCS /40HQ:1100PCS
- 70CM: 20GP:416PCS/40GP: 832PCS /40HQ:910PCS
- 80CM: 20GP:364PCS/40GP:728PCS /40HQ:830PCS
- 90CM: 20GP:320PCS/40GP:650 PCS /40HQ:700PCS

*Warming your heart  
with sunshine at home !*

High efficiency, energy saving,  
safety, environmental protection

**GAS HEATERS**





**LI138A**



**LI168A**



**LI188A**



**LI188**



**LI138**



**LI168**



Convenient mobile heater with Piezo-electric Ignition  
 Forged-copper valve durable  
 Infrared Ceramic Burner Three Power Setting  
 Flameout automatic gas cut safety device/ODS/Tip over  
 Caster for easy free movements  
 Space for cylinder up to 15Kg

Gas type: LPG/BUTANE/PROPANE  
 Gas input: 1.4KW(min)/2.8KW(med)/4.2KW(max)  
 Gas consumption: 110h/h(min)/200g/h(med)/305g/h(max)  
 Heating areas:20-80cubic meters  
 20"GP/40HQ: 225/539pcs/



Convenient mobile heater with Piezo-electric Ignition  
 Forged-copper valve durable  
 Infrared Ceramic Burner Three Power Setting  
 Flameout automatic gas cut safety device/ODS/Tip over  
 Caster for easy free movements  
 Space for cylinder up to 15Kg

Gas type: LPG/BUTANE/PROPANE  
 Gas input: 1.4KW(min)/2.8KW(med)/4.2KW(max)  
 Gas consumption: 110h/h(min)/200g/h(med)/305g/h(max)  
 Heating areas:20-80cubic meters  
 20"GP/40HQ: 300/700pcs



**LI138A-K**



**LI188A-K**



**LI168A-K**



**LI238H**



**LI238QH**

Convenient mobile heater with Piezo-electric Ignition  
 Forged-copper valve durable  
 Infrared Ceramic Burner Three Power Setting  
 Flameout automatic gas cut safety device/ODS/Tip over  
 Caster for easy free movements  
 Space for cylinder up to 15Kg

Gas type: LPG/BUTANE/PROPANE  
 Gas input: 1.4KW(min)/2.8KW(med)/4.2KW(max)  
 Gas consumption: 110h/h(min)/200g/h(med)/305g/h(max)  
 Heating areas:20-80cubic meters  
 20'GP/40HQ:225PCS/539PCS

Convenient mobile heater with Piezo-electric Ignition  
 Forged-copper valve durable  
 Infrared Ceramic Burner Three Power Setting  
 Flameout automatic gas cut safety device/ODS/Tip over  
 Caster for easy free movements  
 Space for cylinder up to 15Kg  
 With blower in hot wind Motor power 15W  
 HeatingWire:1300W-1600W  
 Voltage:220V-240V /50Hz  
 Electric part with overheat protection

Gas type: LPG/BUTANE/PROPANE  
 Gas input: 1.4KW(min)/2.8KW(med)/4.2KW(max)  
 Gas consumption: 110h/h(min)/200g/h(med)/305g/h(max)  
 Heating areas:20-80cubic meters  
 20'GP/40HQ: 225/539pcs

Convenient mobile heater with Piezo-electric Ignition  
 Forged-copper valve durable  
 Infrared Ceramic Burner Three Power Setting  
 Flameout automatic gas cut safety device/ODS/Tip over  
 Caster for easy free movements  
 Space for cylinder up to 15Kg  
 Electric power 1.2KW,3pcs 400W heating quartz tube  
 Voltage:220V-240V /50Hz  
 With blower in hot wind Motor power 15W  
 HeatingWire1300W-1600W  
 Electric part with overheat protection

Gas type: LPG/BUTANE/PROPANE  
 Gas input: 1.4KW(min)/2.8KW(med)/4.2KW(max)  
 Gas consumption: 110h/h(min)/200g/h(med)/305g/h(max)  
 Heating areas:20-80cubic meters  
 20'GP/40HQ: 225/539pcs



**LI238Q**



**LI268Q**

Convenient mobile heater with Piezo-electric Ignition  
Forged-copper valve durable  
Infrared Ceramic Burner Three Power Setting  
Flameout automatic gas cut safety device/OOS/Tip over  
Caster for easy free movements  
Space for cylinder up to 15Kg  
Electric power 1.2KW,3pcs 400W heating quartz tube  
Voltage:220V-240V /50Hz  
Electric part with overheat protection

Gas type: LPG/BUTANE/PROPANE  
Gas input: 1.4KW(min)/2.8KW(med)/4.2KW(max)  
Gas consumption: 110h/h(min)/200g/h(med)/305g/h(max)  
Heating areas:20-50cubic meters  
20'GP/40HQ: 225/539pcs



**CYLINDER CABINETS**